

WRAP AROUND LINE | TRUNKING WITH WRAP AROUND COVER

WRAP AROUND LINE | GOULOTTE ENVELOPPANTE

Self-extinguishing PVC, UV stabilized Class 1 (UL94-V0)
 PVC auto-extinguible, Stabilisé UV Classe 1 (UL94-V0)

ARTICON wrap around line is the ideal trunking for completing internal and external air conditioning system. Practicality and compactness are the main characteristics. Available in 5 different sizes for MONO and MULTISPLIT air conditioning units. Length 2 mt.

All trunkings are equipped with protective film.

ARTICON wrap around line est la goulotte idéale pour la réalisation de systèmes de climatisation d'air internes et externes. Compacité et praticité sont les principales caractéristiques. Disponible en 5 tailles pour systèmes MONO et MULTISPLIT. Longueur 2 mt.

Tous les goulottes sont munis d'un film de protection.



CON65A



CON65A

65 x 50 mm

24 mt

2530 mm²

20

480

CON70A

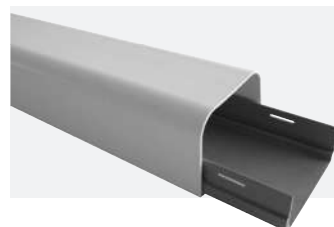

CON70A

70 x 55 mm

20 mt

3056 mm²

20

400

CON80A



CON80A

80 x 60 mm

16 mt

4018 mm²

20

320

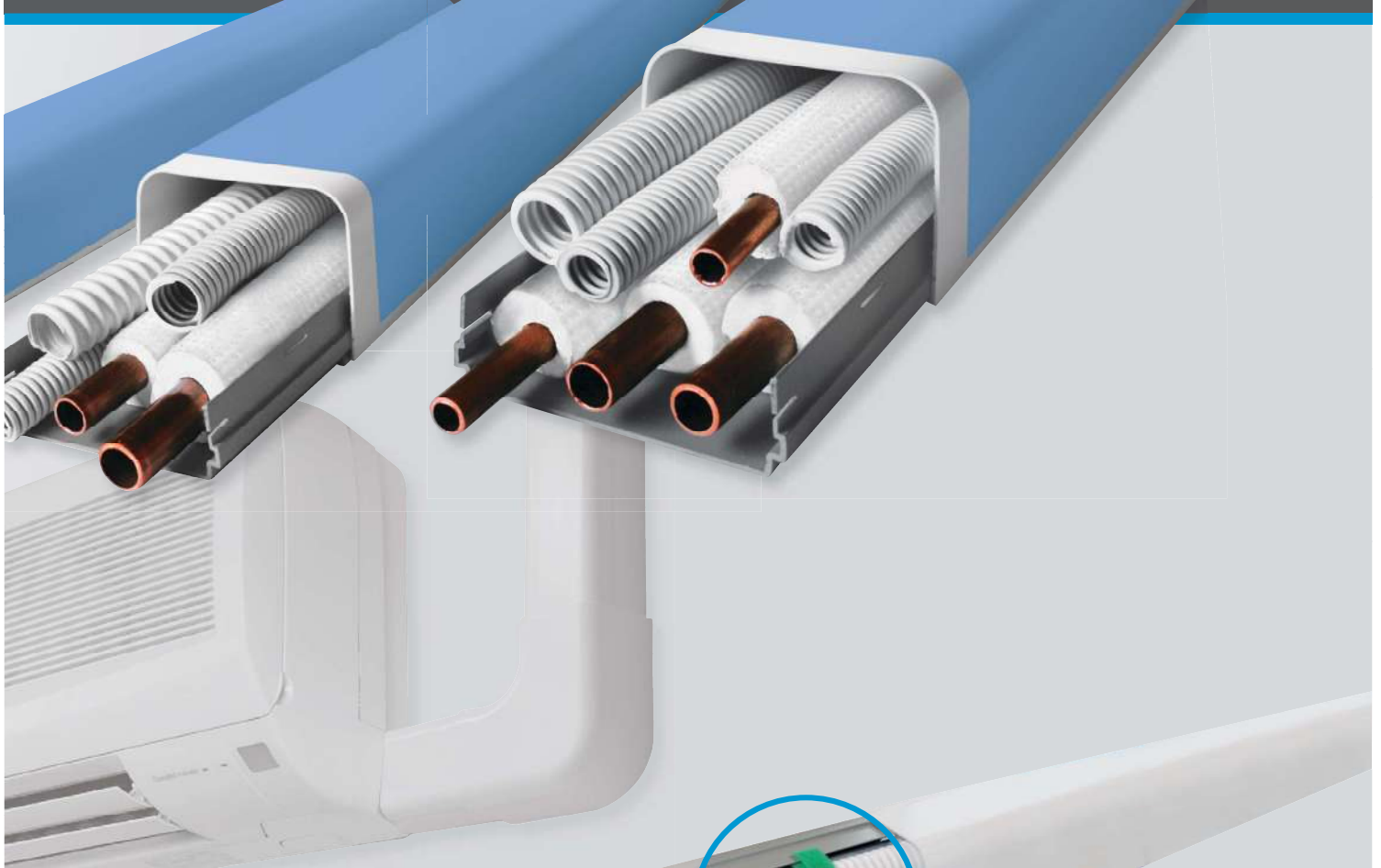

Cable tie
Bride

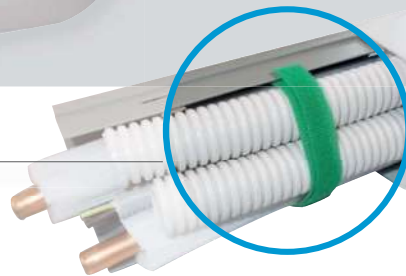

CON90A

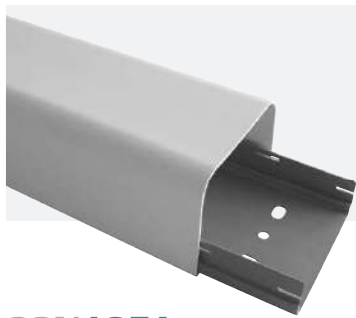

CON90A

90 x 65 mm

16 mt

4830 mm²

20

320

CON125A



CON125A

125 x 75 mm

8 mt

8317 mm²

20

160

SNAP ON LINE | TRUNKING WITH SNAP ON COVER

SNAP ON LINE | GOULOTTE À DÉCLIC

Self-extinguishing PVC, UV stabilized Class 1 (UL94-V0)
 PVC auto-extinguible, Stabilisé UV Classe 1 (UL94-V0)



ARTICON Snap on line is elegant, practical and compact. It is ideal as a complement for internal and external system, available in 6 different sizes in order to satisfy every installation need: MONO, DUAL, MULTISPLIT.

All trunkings are equipped with protective film.

ARTICON Snap on line est élégante, compacte et pratique. Le complément idéal aux systèmes internes et externes, elle est disponible en 6 tailles différentes pour répondre à toute exigence d'installation: MONO, DUAL, MULTISPLIT.

Tous les goulottes sont munis de film de protection.



CON30 Drain pipe trunking
 Goulotte pour tube condensant



		CON30	35 x 30 mm	64 mt	824 mm ²	25	1600
--	--	-------	------------	-------	---------------------	----	------

CON65

		CON65	65 x 50 mm	28 mt	2530 mm ²	20	560
--	--	-------	------------	-------	----------------------	----	-----

CON70

		CON70	70 x 55 mm	24 mt	3056 mm ²	20	480
--	--	-------	------------	-------	----------------------	----	-----



CON80



CON80

80 x 60 mm

20 mt

4018 mm²

20

400

CON90



CON90

90 x 65 mm

16 mt

4830 mm²

20

320

CON125



CON125

125 x 75 mm

8 mt

8317 mm²

25

200

TRUNKING ACCESSORIES

ACCESSOIRES POUR GOULOTTES

UNIVERSAL
WRAP / SNAP

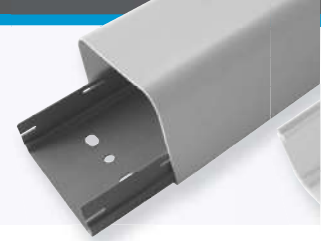

CONG cover joint
joint de couvercle



for trunking:
pour goulotte:



CONG30	35 x 30 mm	25
CONG65	65 x 50 mm	25
CONG70	70 x 55 mm	25
CONG80	80 x 60 mm	25
CONG90	90 x 65 mm	25
CONG125	125 x 75 mm	25

CONAI inner bend
angle interne

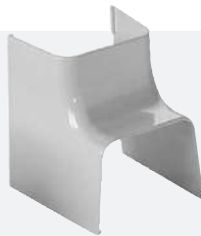

for trunking:
pour goulotte:



CONAI30	35 x 30 mm	20
CONAI65	65 x 50 mm	10
CONAI70	70 x 55 mm	10
CONAI80	80 x 60 mm	10
CONAI90	90 x 65 mm	10
CONAI125	125 x 75 mm	10

CONAE outer bend
angle extérieur



for trunking:
pour goulotte:



CONAE30	35 x 30 mm	20
CONAE65	65 x 50 mm	10
CONAE70	70 x 55 mm	10
CONAE80	80 x 60 mm	10
CONAE90	90 x 65 mm	10
CONAE125	125 x 75 mm	10

CONCP flat bend
courbe plane

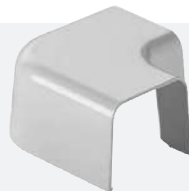

for trunking:
pour goulotte:



CONCP30	35 x 30 mm	20
CONCP65	65 x 50 mm	10
CONCP70	70 x 55 mm	10
CONCP80	80 x 60 mm	10
CONCP90	90 x 65 mm	10
CONCP125	125 x 75 mm	10

CONTP end cap
embout



for trunking:
pour goulotte:



CONTP30	35 x 30 mm	20
CONTP65	65 x 50 mm	10
CONTP70	70 x 55 mm	10
CONTP80	80 x 60 mm	10
CONTP90	90 x 65 mm	10
CONTP125	125 x 75 mm	10

universal trunking accessories for WRAP and SNAP
 accessoires universelles pour les modèles WRAP et SNAP

UNIVERSAL
 WRAP / SNAP



CONPAM wall-routing
 passage à mur



for trunking:
 pour goulotte:



CONPAM65	65 x 50 mm	10
CONPAM70	70 x 55 mm	10
CONPAM80	80 x 60 mm	10
CONPAM90	90 x 65 mm	10
CONPAM125	125 x 75 mm	10

CONCM wall-routing bend
 courbe de passage à paroi



for trunking:
 pour goulotte:



CONCM65	65 x 50 mm	10
CONCM70	70 x 55 mm	10
CONCM80	80 x 60 mm	10
CONCM90	90 x 65 mm	10
CONCM125	125 x 75 mm	10

CONCT "T" joint deviation
 dérivation en "T"



for trunking:
 pour goulotte:



CONCT80	80 x 60 mm	6
CONCT90	90 x 65 mm	6
CONCT125	125 x 75 mm	6

CONGU joint with gasket
 joint avec garniture



for trunking:
 pour goulotte:



CONGU65	65 x 50 mm	10
CONGU70	70 x 55 mm	10
CONGU80	80 x 60 mm	10
CONGU90	90 x 65 mm	10

CONRD trunking reduction
 réduction de goulotte



for trunking:
 pour goulotte:



use feat
 utiliser avec:



CONRD90	90x65 → 70x55 mm	10	CONG90
CONRD125	125x75 → 90x65 mm	10	CONG125

CONVG flange accessory
 accessoire convoyeur



for trunking:
 pour goulotte:



CONVG110-90	90 x 65 mm	8
-------------	------------	---